

預 備
starting position

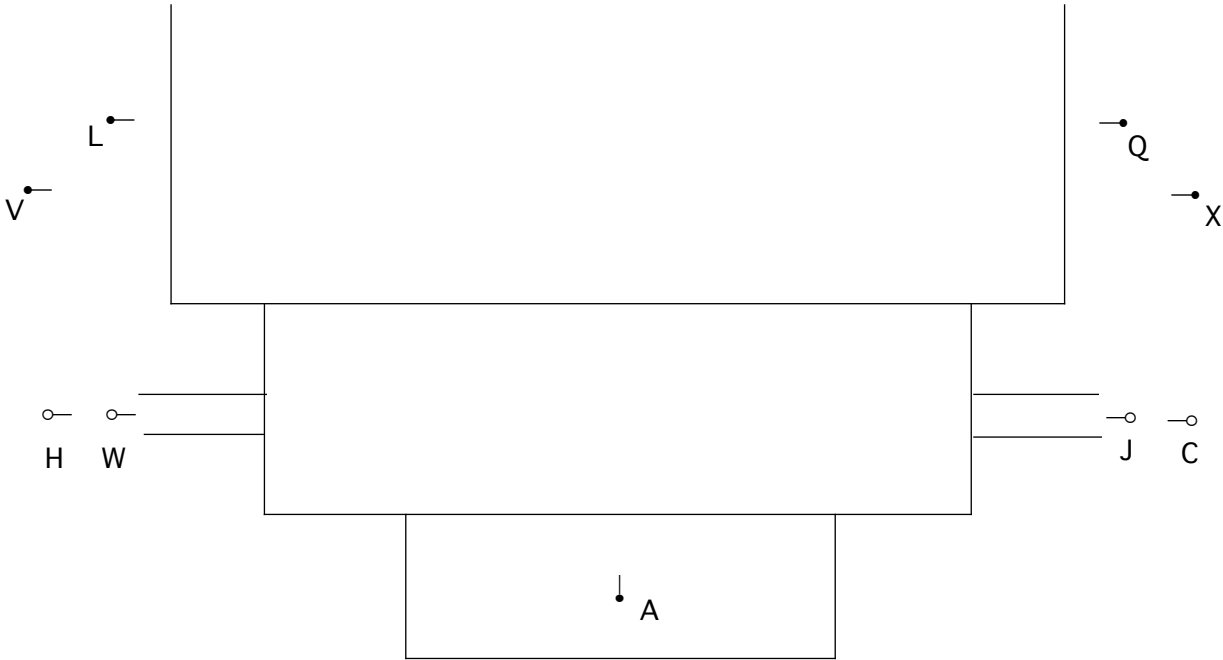

2 Joy of drinking a toast
- entrance

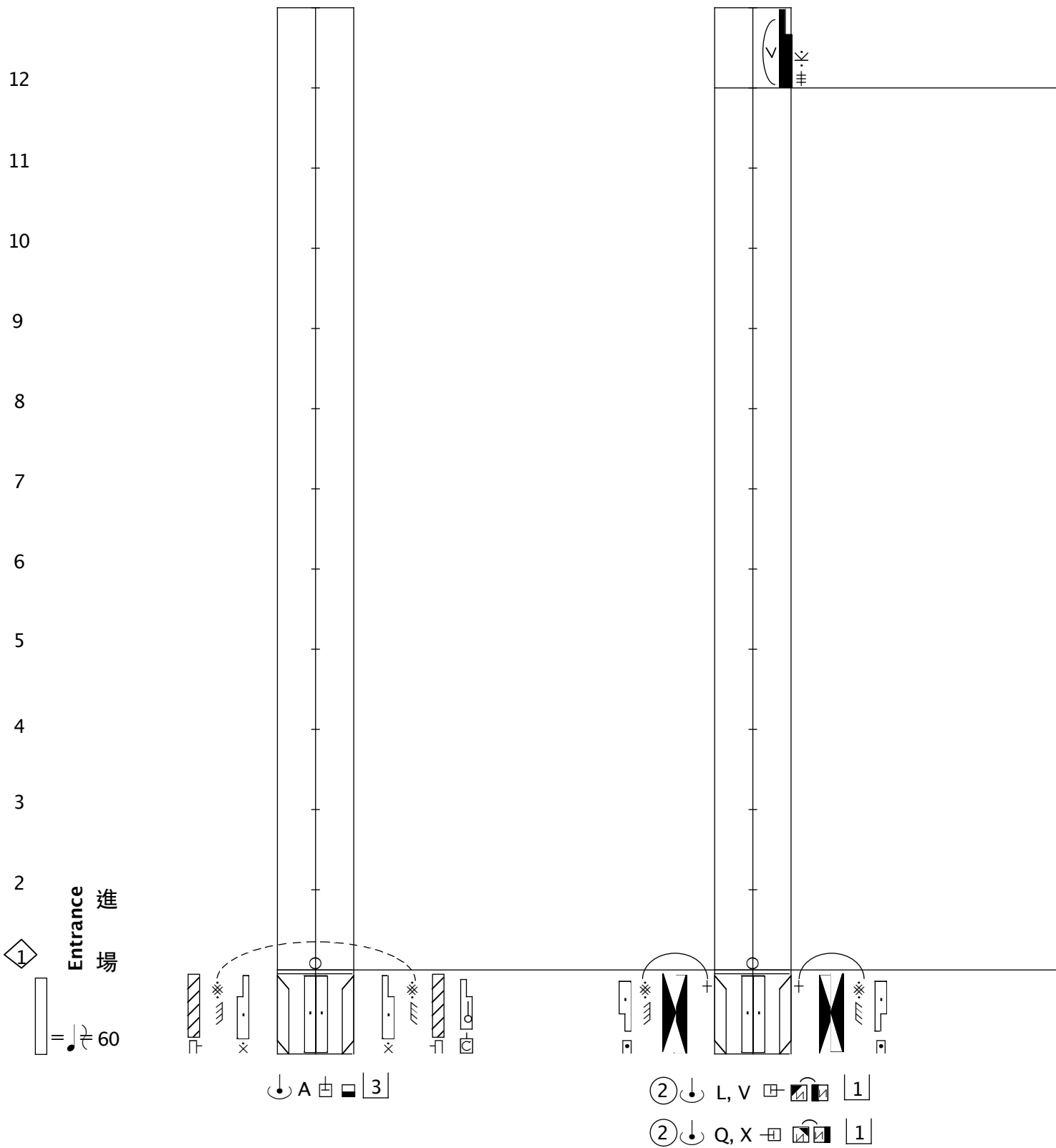

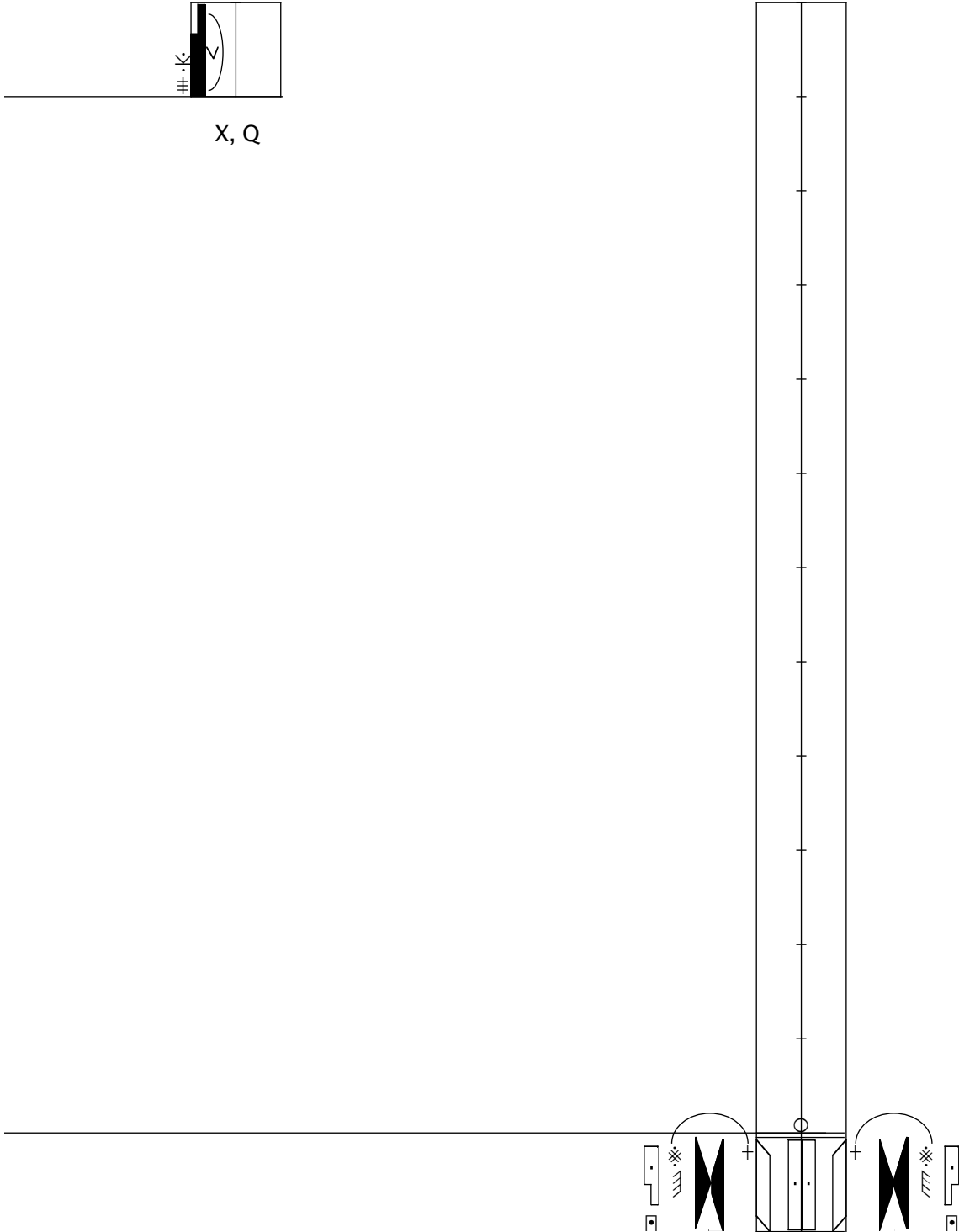
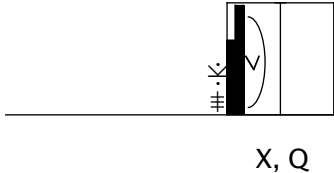

- ② ⓪ H, W □ ▣ | 2
- ② ⓪ J, C □ ▣ | 2

4 Joy of drinking a toast
- entrance

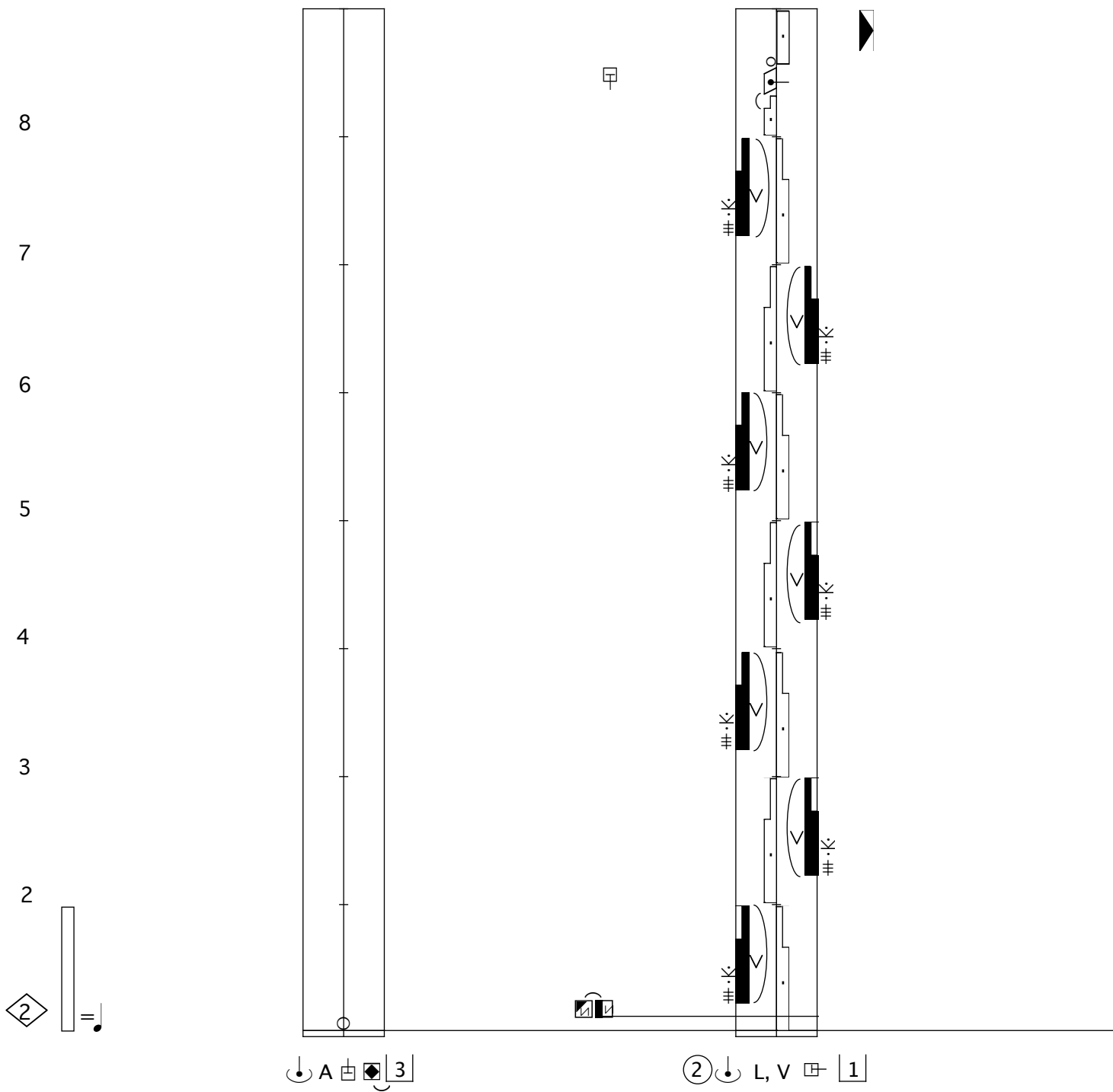

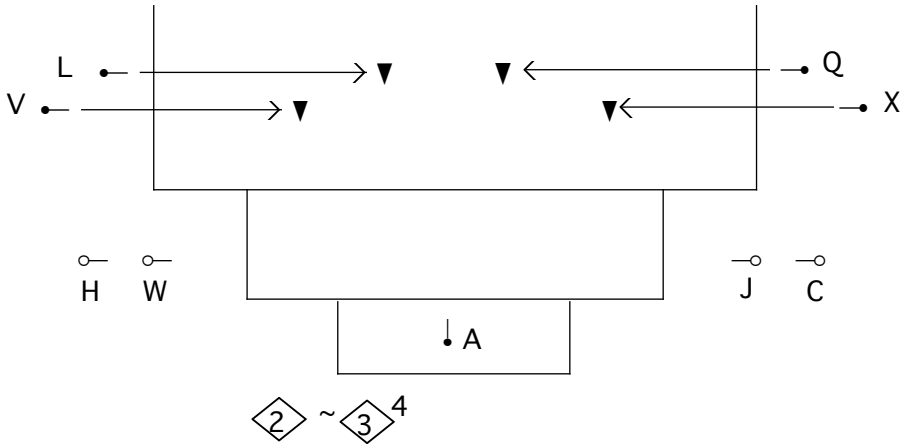

甲

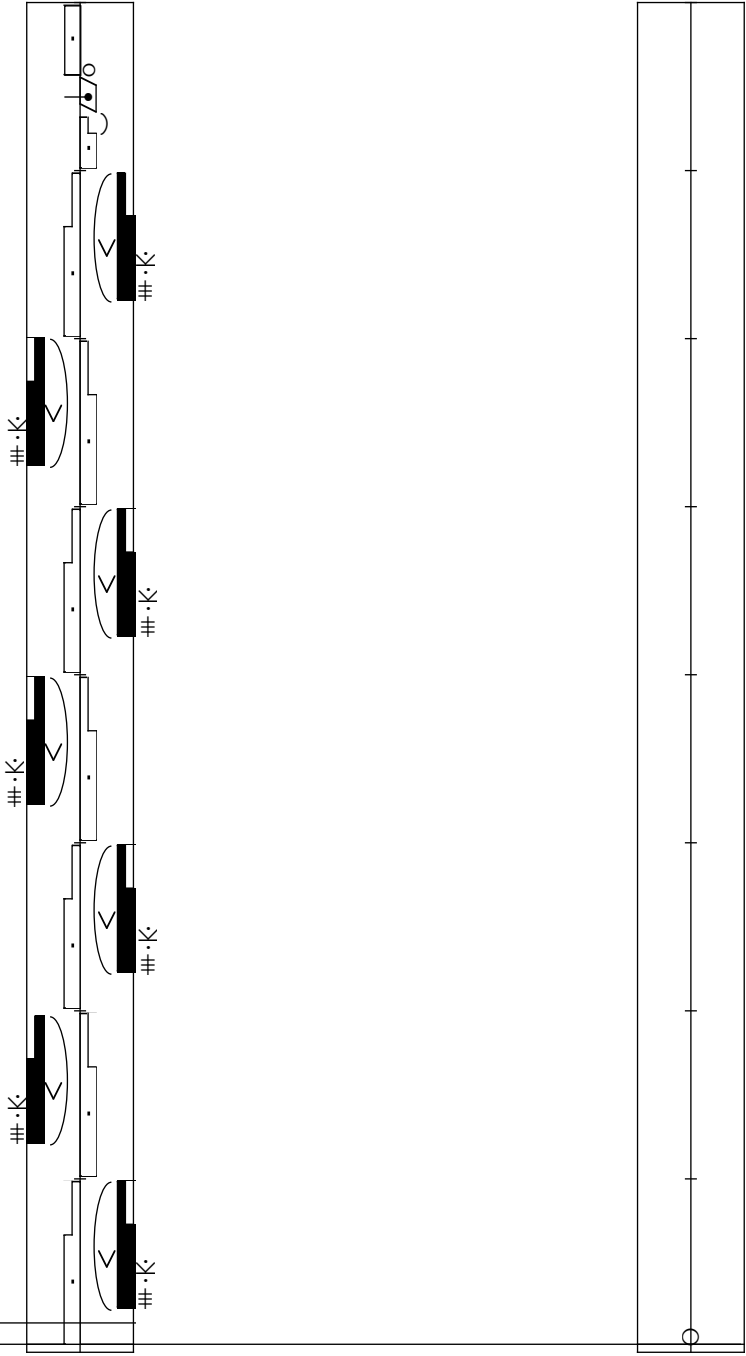

② ↓ Q, X 甲 [1]

② ↓ H, W 甲 [2]

② ↓ J, C 甲 [2]

6 Joy of drinking a toast
- entrance

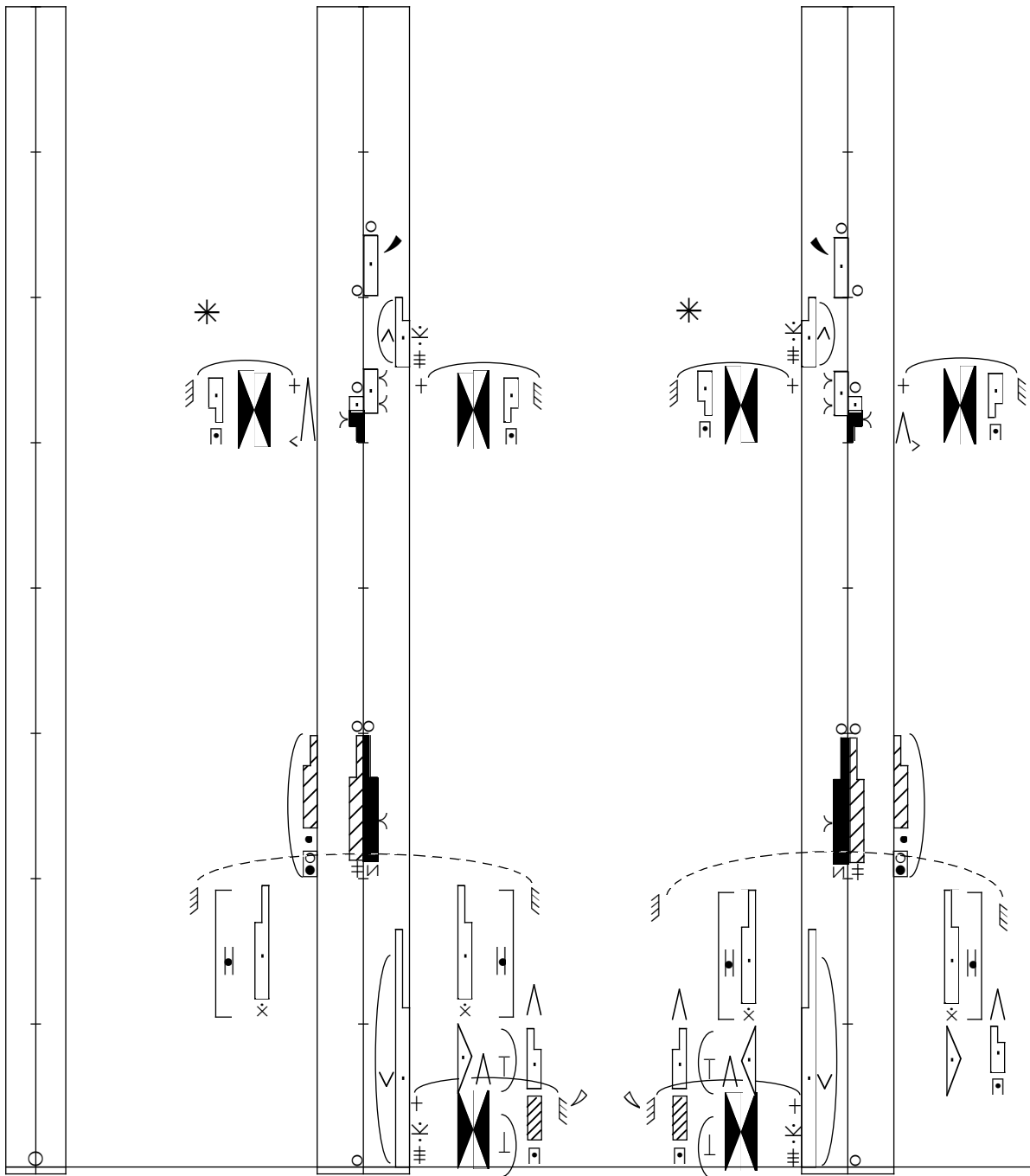
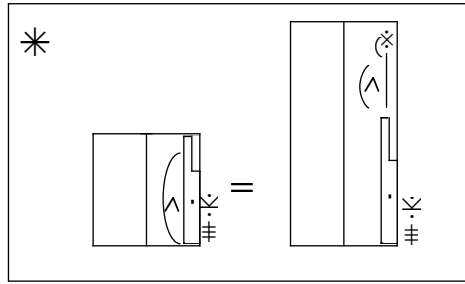

3

↓ A 由 3

② ↓ L, V 甲 1

② ↓ Q, X 甲 1

climb the stairs
上
樓
梯

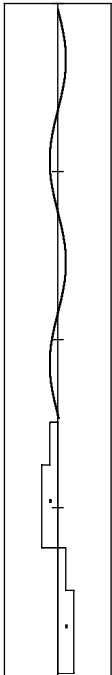

climb the stairs
上
樓
梯

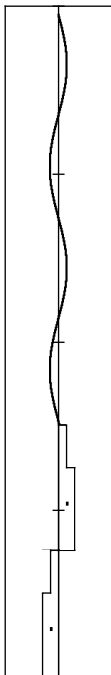

② ⓪ J, C ㊦

② ⓪ H, W ㊦ ㊦ | 2 |
② ⓪ J, C ㊦ ㊦ | 2 |

8 Joy of drinking a toast
- entrance

4

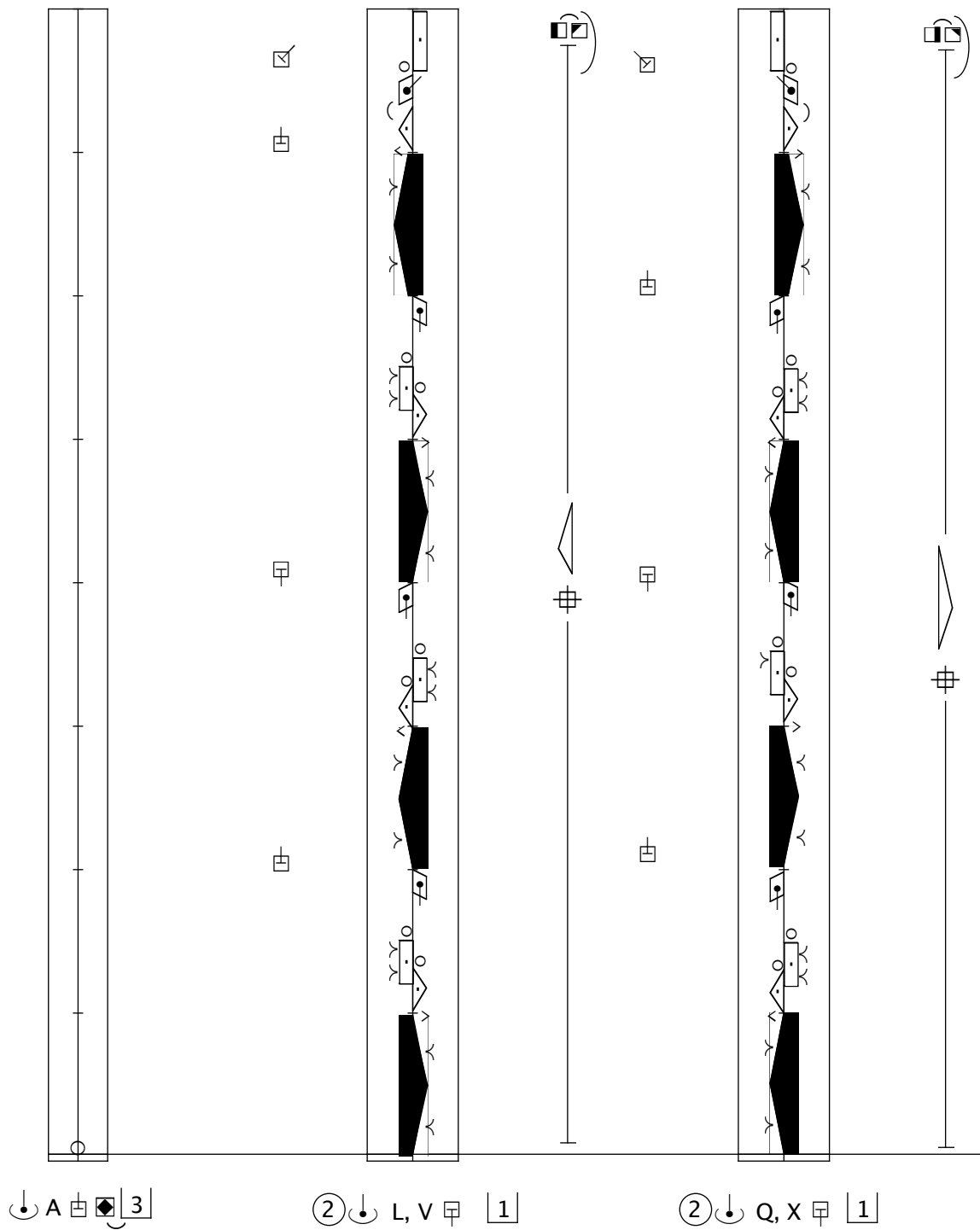

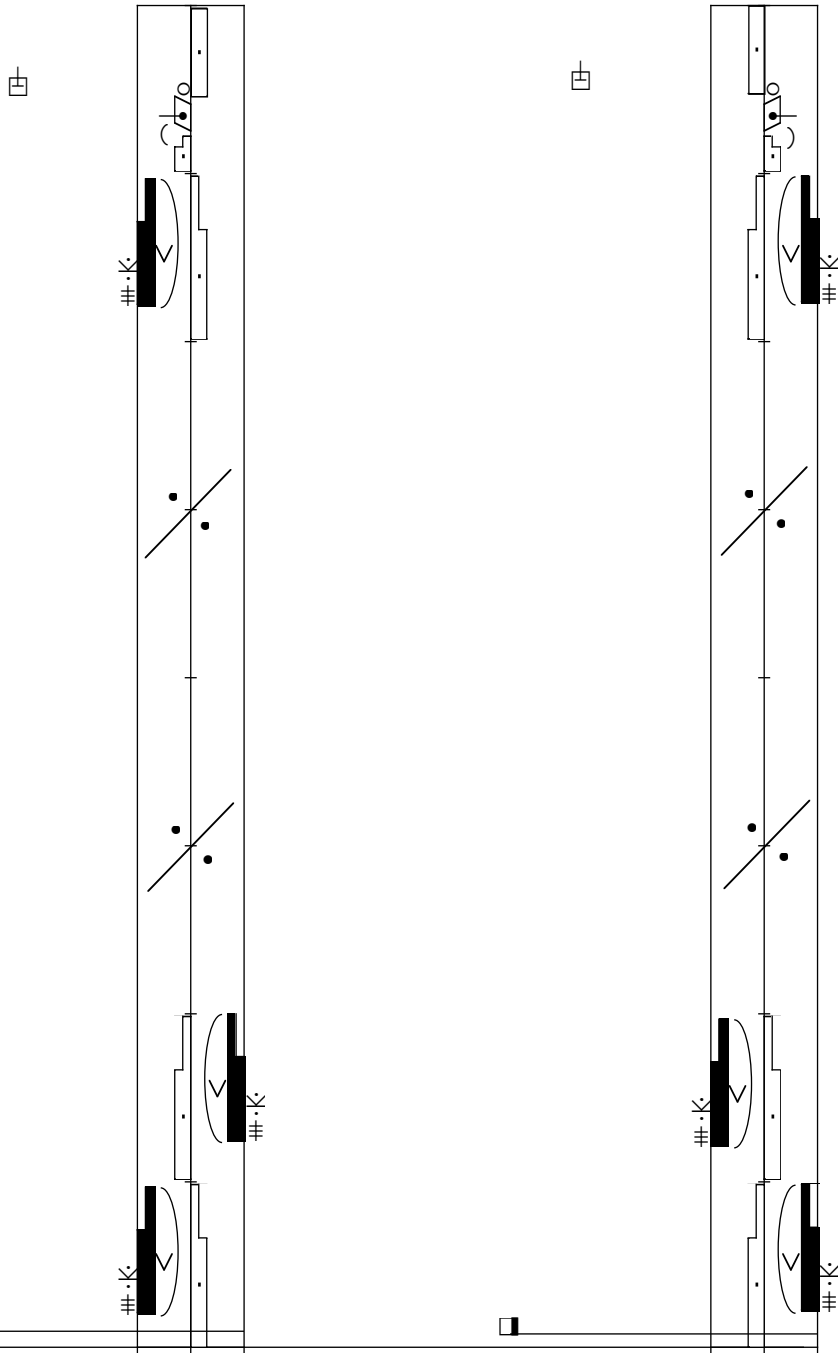
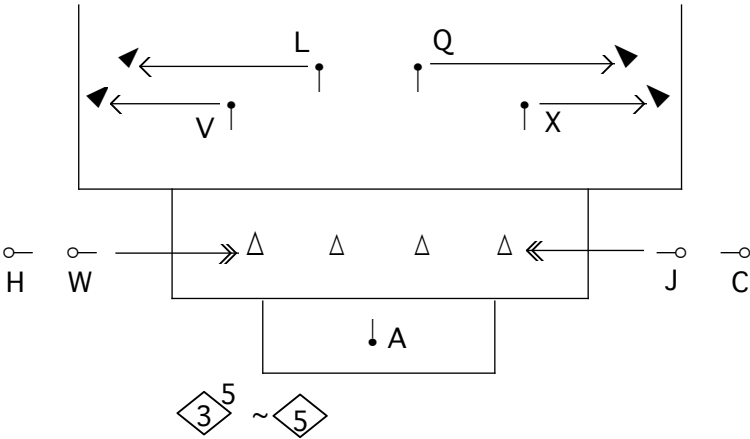

② H, W 2

② J, C 2

10 Joy of drinking a toast
- entrance

5

